

REVISIONS			
REV.	DESCRIPTION	DATE	APPROVED
G	As Released	7/15/1998	SECO

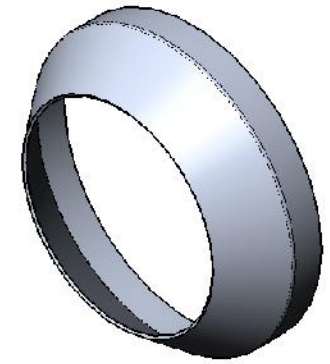
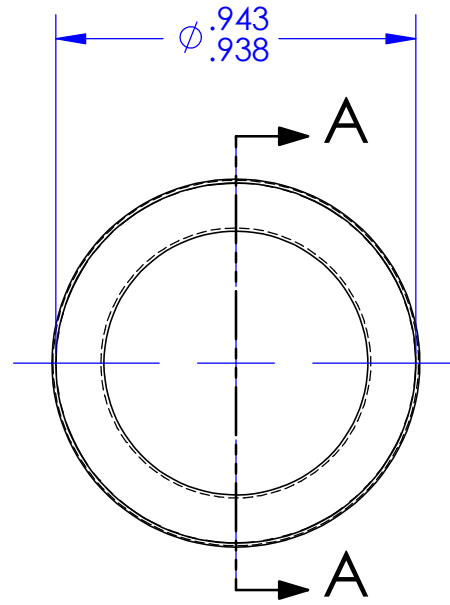
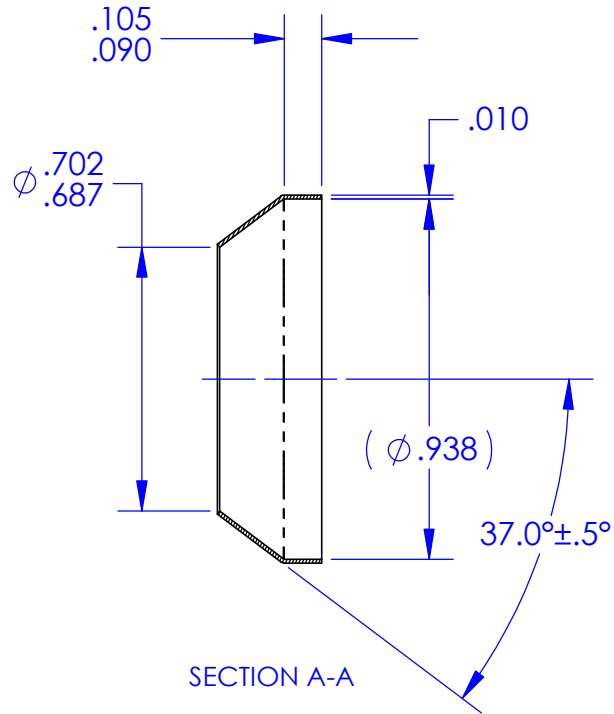

NOTES: UNLESS OTHERWISE SPECIFIED

1. MATERIAL: ALUMINUM ALLOY 1100 SHEET, CONDITION "0" PER QQ-A-250/1, QQ-A-1876 OR AMS 4001.
2. FINISH: NONE.
3. THESE PARTS ARE ANNEALED. DIMENSIONS "A" AND "C" SHALL BE VERIFIED BY INSTALLING THE SEAL ON A STANDARD FITTING PER MS33514 OF APPROPRIATE SIZE. AN OUT-OF ROUND CONDITION WHICH DOES NOT PREVENT SUCH INSTALLATION SHALL NOT BE A CAUSE FOR REJECTION UNLESS THE SEAL MATERIAL IS CREASED OR NICKED.
4. BREAK ALL SHARP EDGES AND REMOVE ALL BURRS.

ECCN 9A991.d		DRAWING SIZE		SECO SEALS, INC.	1370 LOGAN AVE. UNIT K	(714) 546-3478
MAT'L:	FSCM:			sales@secoseals.com	COSTA MESA, CA. 92626	www.secoseals.com
See Note 1	4730		FILE NAME:	SECO7A12		REV.
TREATMENT:	INCHES DIMENSIONS IN INCHES 3RD ANGLE PROJECTION 	DESC.:	Conical Seal for 3/4" Flared Tube Fitting, 37 Degree.		STANDARD:	
Annealed after Forming		TITLE:	SECO 7 Seal		SECO 7	
MAT'L SIZE:		DATE DRAWN	SCALE	DRAWN BY	CAGE CODE:	
.010 Thk. Sheet		4/8/2015	2:1	Joe Littel	33447	
				CHECKED BY	SHEET	
				Jim Scott	1 of 1	