

REVISIONS			
REV.	DESCRIPTION	DATE	APPROVED
G	As Released	7/15/1998	SECO

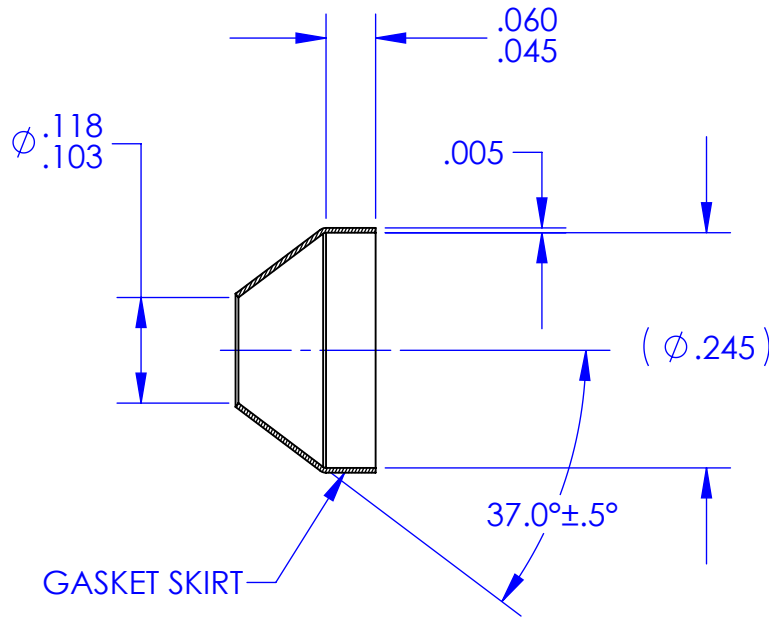

SECTION A-A

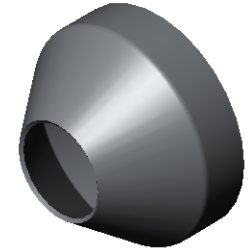
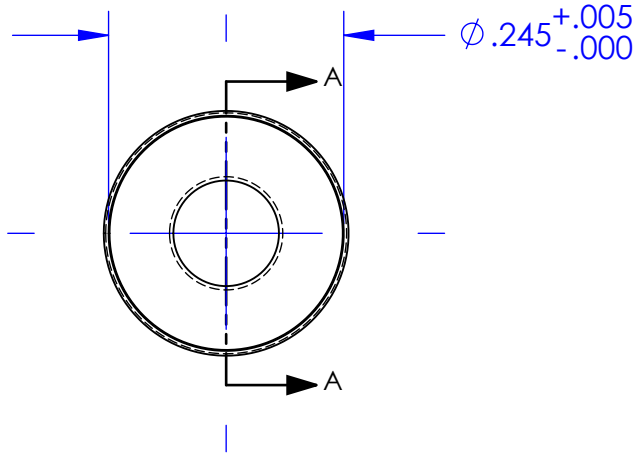

NOTES: UNLESS OTHERWISE SPECIFIED

1. MATERIAL: NICKEL STRIP 201, PER ASTM B 162 OR AMS 5553.
2. FINISH: SILVER PLATED PER AMS 2410.
3. THESE PARTS ARE ANNEALED. DIMENSIONS "A" AND "C" SHALL BE VERIFIED BY INSTALLING THE SEAL ON A STANDARD FITTING PER MS33514 OF APPROPRIATE SIZE. AN OUT-OF ROUND CONDITION WHICH DOES NOT PREVENT SUCH INSTALLATION SHALL NOT BE A CAUSE FOR REJECTION UNLESS THE SEAL MATERIAL IS CREASED OR NICKED.
4. BREAK ALL SHARP EDGES AND REMOVE ALL BURRS.

ECCN 9A991.d		DRAWING SIZE	SECO SEALS, INC. 1370 LOGAN AVE. UNIT K (714) 546-3478 PO BOX 1461 COSTA MESA, CA. 92626 www.secoseals.com	
MAT'L: See Note 1	FSCM: 4730	A	FILE NAME: SECO7NS2	REV. G
TREATMENT: Annealed after Forming	INCHES DIMENSIONS IN INCHES 3RD ANGLE PROJECTION 	DESC.: Conical Seal for 1/8" Flared Tube Fitting, 37 Degree.		STANDARD: SECO 7
MAT'L SIZE: .005 Thk. Sheet		TITLE: SECO 7 Seal	DRAWN BY: Joe Littel	CAGE CODE: 33447
DATE DRAWN 4/21/2015		SCALE 5:1	CHECKED BY Jim Scott	SHEET 1 of 1