

REVISIONS			
REV.	DESCRIPTION	DATE	APPROVED
G	As Released	7/15/1998	SECO

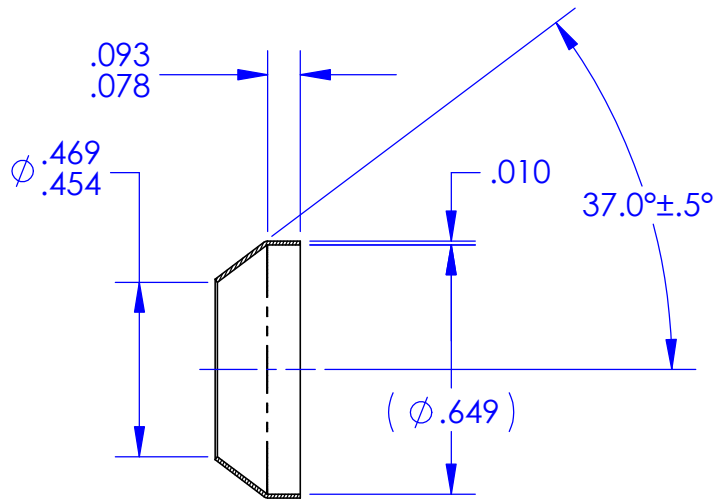

SECTION A-A

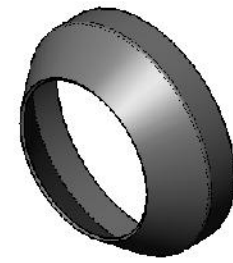
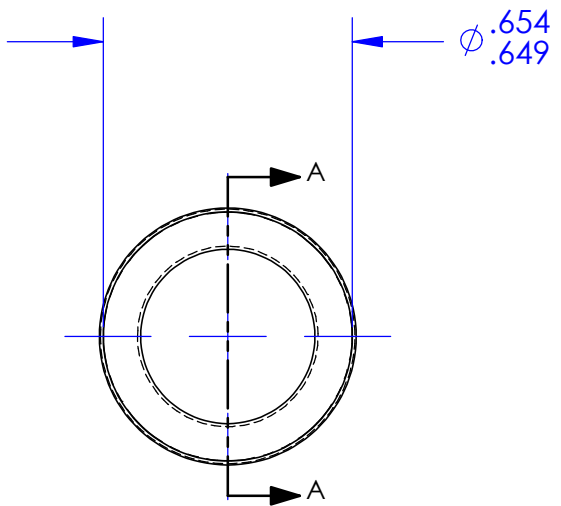

**NOTES: UNLESS OTHERWISE SPECIFIED**

1. MATERIAL: ALUMINUM ALLOY 1100 SHEET, CONDITION "0" PER QQ-A-250/1, QQ-A-1876 OR AMS 4001.
2. FINISH: NONE.
3. THESE PARTS ARE ANNEALED. DIMENSIONS "A" AND "C" SHALL BE VERIFIED BY INSTALLING THE SEAL ON A STANDARD FITTING PER MS33514 OF APPROPRIATE SIZE. AN OUT-OF ROUND CONDITION WHICH DOES NOT PREVENT SUCH INSTALLATION SHALL NOT BE A CAUSE FOR REJECTION UNLESS THE SEAL MATERIAL IS CREASED OR NICKED.
4. BREAK ALL SHARP EDGES AND REMOVE ALL BURRS.

ECCN 9A991.d		DRAWING SIZE	SECO SEALS, INC. 1370 LOGAN AVE. UNIT K (714) 546-3478 sales@secoseals.com COSTA MESA, CA. 92626 www.secoseals.com	
MAT'L: See Note 1	FSCM: 4730	<b>A</b>	SECO SEALS	REV. G
TREATMENT: Annealed after Forming	INCHES DIMENSIONS IN INCHES 3RD ANGLE PROJECTION	DESC.: Conical Seal for 1/2" Flared Tube Fitting, 37 Degree.		STANDARD: SECO 7
MAT'L SIZE: .010 Thk. Sheet		TITLE: SECO 7 Seal	DRAWN BY: Joe Littell	CAGE CODE: 33447
		DATE DRAWN: 4/8/2015	SCALE: 2:1	CHECKED BY: Jim Scott
				SHEET 1 OF 1